

Suzuki GSX-R K3

Plug&Play kit

User Manual



Racing Data Power

SUMMARY

Preface.....	4
1 – Kit description.....	5
1.1 – Part Numbers (see Appendix “A”).....	7
2 – Plug & Play kits installation	8
2.1 – Removing the lateral mirrors and the front and lateral fairings.....	9
2.2 – Removing the bike seat and lifting the fuel tank.	11
2.3 – Releasing the high beam and the front fairing screws.	12
2.4 – Removing the stock dash; unplugging the connectors.....	12
2.5 – Assembling the kit.	14
2.6 – Cables connection	15
2.7 – Installing the kit.....	16
2.8 – Installing the TPS cable.....	17
3 – MXL connection inputs	18
4 – MXL GSX-R K3 firmware	19
5 – Configuration	20
6 – Gear calibration	25
6.1 – Saving the configuration with custom gear calibration.....	28
7 – Equivalent circumference compute	29
8 – TPS sensor configuration	30
9 – Channels.....	32
10 – Data download and analysis.....	33
11 – MXL optional expansions.....	33
11.1 – Appendix “A” MXL for Suzuki GSX-R K3 kit wirings.....	34
11.2 – Appendix “B” TPS Cable.....	40

PRESENTATION

AIM: a world leader in data acquisition for racing environment.

Established in 1976, AIM is today a world leader in the production of high performances instruments for racing environment: dashes, data loggers, digital displays, lap timers.

AIM set new standards in various motor sports: from kart to car, bike, dragster, Formula 1 boat, Offshore and even snowboards!

AIM products merges the functionalities of traditional tachometers, RPM indicators, temperature, pressure and lap timers with compact high performing friendly using units. Different products for different applications but with one shared characteristic: great innovation.

Each **AIM** system is completely designed, produced and tested by its technicians. The research and development board is made of electronic and mechanical engineers, physics and other specialists that develop firmware, software, hardware and the related documentation.

Our fame is build on quality products, innovative technology and faithful commitment in supporting our customers.

Preface

MXL Plug & Play kit for **Suzuki GSX-R K3** is the dashboard (with data logger function in **Pista** version) designed for an easy and quick installation: with a minimum effort a straight connection with the bike ECU is made and a lot of different information (depending on the logger model) are displayed with no need of additional sensors:

MXL STRADA

- RPM
- Speed
- Water temperature
- Oil Pressure Signal
- Fuel level
- Turning lights
- High beam
- Engaged gear
- 2 free channels

MXL PISTA

- RPM
- Speed
- Water temperature
- Engaged gear
- 6 free channels

The logger, like the stock dash, is powered by the bike master switch.

MXL Strada and **Pista** for **Suzuki GSX-R K3** kits have been developed for the following bike models:

Cubic capacity	Year 2003	Year 2004	Year 2005
600	√	√	√
750	√	√	√
1000	√	√	See K5 manual

√= supported

Note: thanks to the optical IR transmitter/receiver (included in **MXL Pista** kit, optional to **MXL Strada**), lap times will be displayed/recorded.

For any additional information not expressly handled in this tutorial, always refer to **MXL** user manual and/or to **Race Studio Configuration** user manual.

1 – Kit description



Suzuki GSX-R K3 Plug & Play kits differ depending on the version of **MXL**. Each type of kit includes some of the objects shown in the above picture, recognizable by their numbers:

MXL Strada kit:

N.1 – **MXL Strada** (1)

N.1 – **Suzuki GSX-R K3** interface wiring (2)

N.1 – USB cable for **MXL** (6)

N.1 – Leaflet MXL Suzuki GSX-R K3(7)

N.1 – Race Studio 2 software CD (8)

N.1 – Bracket kit (10) that includes:

n° 4 Phillips 4*8 mm recess screws

n° 2 Phillips 5*12 mm recess screws

n° 4 Grover washers Ø 4 mm

n° 4 washers Ø 5 mm

n° 4 Phillips threading forming recess screws 40*12



MXL Pista kit:

- N.1 – MXL pista (1)
- N.1 – **Suzuki GSX-R K3** interface wiring (2)
- N.1 – IR Transmitter (3)
- N.1 – IR receiver (4)
- N.1 – Transmitter power cable (5)
- N.1 – USB cable for MXL (6)
- N.1 – Leaflet AIM products (7)
- N.1 – **Race Studio 2** software CD (8)
- N.1 – TPS – throttle position sensor - cable (9)
- N.1 – Bracket kit (10) that includes:
 - n° 4 Phillips 4*8 mm recess screws
 - n° 2 Phillips 5*12 mm recess screws
 - n° 4 Grover washers Ø 4 mm
 - n° 4 washers Ø 5 mm
 - n° 4 Phillips threading forming recess screws 40*12

Universal kit (for customers that already have an MXL Strada, Pista):

- N.1 – Universal interface cable for **Suzuki GSX-R K3** (2)
- N.1 – Bracket kit (10) that includes:
 - n° 4 Phillips 4*8 mm recess screws
 - n° 2 Phillips 5*12 mm recess screws
 - n° 4 Grover washers Ø 4 mm
 - n° 4 washers Ø 5 mm
 - n° 4 Phillips threading forming recess screws 40*12

MXL Strada optional

- N.1 – IR transmitter (3)
- N.1 – IR receiver (4)
- N.1 – Transmitter power cable (5)
- N.1 – TPS – throttle position sensor cable (9)

Note: before starting kit installation it is suggested to carefully verify that the kit contains all listed items.

1.1 – Part Numbers (see Appendix “A”)

MXL Strada Plug&Play kit for **Suzuki GSX-R600-750 K3** – code **X10MXLSGS3467**:

- only CAN connection + analog channels;
- technical draw code 04.554.14.

MXL Strada Plug&Play kit for **Suzuki GSX-R1000 K3** – code **X10MXLSGS3410**:

- only CAN connection + analog channels;
- technical draw code 04.554.14.

MXL Pista Plug&Play kit for **Suzuki GSX-R600-750 K3** – code **X10MXLCGS3467**

- only CAN connection + analog channels;
- technical draw code 04.554.13.

MXL Pista Plug&Play kit for **Suzuki GSX-R1000 K3** – code **X10MXLCGS3410**

- only CAN connection + analog channels;
- technical draw code 04.554.13.

Universal kit for **MXL Strada Suzuki GSX-R K3** (wiring + bracket) – code **V02554140**

- to transform an MXL Strada into a Plug&Play application for Suzuki GSX-R K3;
- technical draw code: 04.554.14

Universal kit for **MXL Pista Suzuki GSX-R K3** (wiring + bracket): code **V02554130**

- to transform an MXL Pista in Plug&Play application for Suzuki GSX-R K3;
- technical draw code 04.554.13

Optional to **MXL Strada Suzuki K3** kit

- IR receiver: code **X41RX12090**
- IR transmitter: code **X02TXKMA01**
- transmitter power cable: code **V02POWTX0**
- TPS cable – throttle position sensor – Suzuki GSX-R K3: code **V02550690**

2 – Plug & Play kits installation

Suzuki GSX-R K3 Plug and Play kits have been expressly designed to be real plug and play systems.

WARNING: these kits have been developed and tested to guarantee maximum compatibility with the stock bike sold by the manufacturer.

The anchor plugs mounted on the back of the logger allows the user to replace the stock dash in an easy and quick way with no need of cutting, bending or punching anything: each component is “Plug and Play”.

The logger needs to be connected to the bike high beam using the bracket that comes with the kit. The bracket is in black anodized aluminium, lightweight and mechanically resistant.

GENERAL NOTES – Read carefully these instruction before installing the kit.

- Non tagliare alcun cavo: il cablaggio fornito con il kit è **Plug & Play**.
- Si faccia attenzione a non danneggiare i connettori di bordo nel collegarli / scollegarli; nelle pagine seguenti è descritto come maneggiarli correttamente.
- Non installare il sistema quando il motore è caldo: i connettori di bordo sono abbastanza vicini al motore e ci si potrebbe scottare.
- Lo spazio sotto il serbatoio è abbastanza ristretto: si usi prudenza nel collegare / scollegare i connettori.
- Si faccia attenzione a non perdere viti e rondelle.
- Si faccia attenzione a non danneggiare le carene nell'installarle/disinstallarle.

2.1 – Removing the lateral mirrors and the front and lateral fairings

The first installation step is removing lateral mirrors and front and lateral fairings.

Lateral mirrors are fixed to the bike chassis with two hex screws that have a plastic cover. To remove the covers see **Figure 1**.



Figure 1: plastic covers removal.

It is then possible to remove the hex screws shown in **Figure 2**.

Both mirrors need to be removed.



Figure 2: hex screws.

Afterwards remove the front screen and the right lateral fairing.

It is suggested to remove the front screen to uninstall the stock dash and install the new one.

The fairing is fixed to the bike with four Phillips thread forming screws.

In **Figure 3** the position of the screws is shown: remove them.



Figure 3: front screen – 4 Phillips thread forming screws.

The logger wiring is to be installed on the bike right side.

It is only required removal of the right lateral fairing, fixed to the chassis through 6 hex screws and four plastic pins. Screws are red circled in **Figure 4** while pins are highlighted by red/yellow arrows in **Figures 4 and 5**.

The plastic pin on **Figure 4** is only visible looking at the bike frontally.



Figure 4: right lateral fairing – screws and pins.

The remaining three plastic pins are on the bottom part of the bike.

To correctly remove them refer to **Figures 6 and 7**.

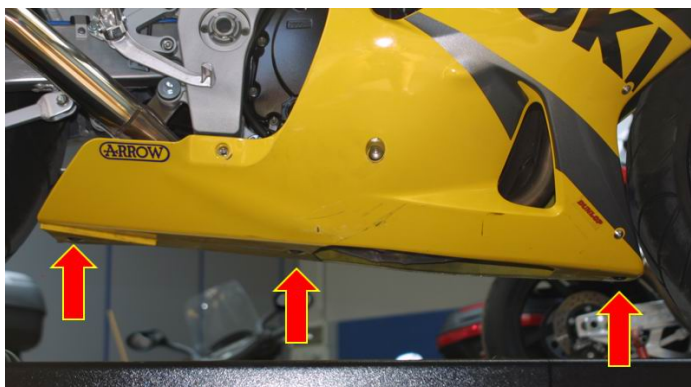

Figure 5: Right and left fairings junction – pins position.

Insert a tip in the central hole of the pin and press until you hear a click. This way the pin is released.



Figure 6: release the central clip of the plastic pin.

Once the pin released it is possible to remove it. Use a flat screwdriver: insert under the pin and rotate it. All the three pins have to be removed. When all hex screws and pins are removed the right lateral fairing is released.



Figure 7: removal of the plastic pin

2.2 – Removing the bike seat and lifting the fuel tank.

Some bikes connectors are very near to the engine and placed under the fuel tank; it is then required to lift the latter.

To lift it remove the bike seat, which is fixed to the bike with two screws. In **Figure 8** the left screw is indicated.

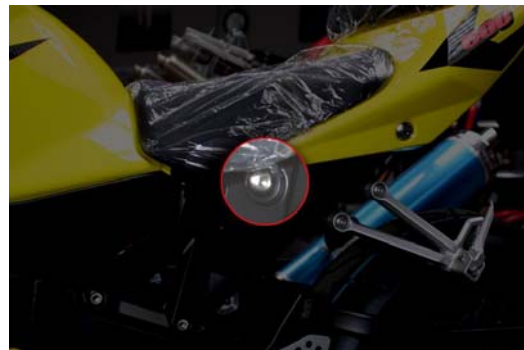

Figure 8: bike seat

Remove the two lateral screws of the bike seat as shown in **Figure 9**.

It is now possible to remove the bike seat.



Figure 9: unscrew the bike screws

The fuel tank is hinged to the chassis near to the seat and fixed with two hex screws placed close to the fork. Unscrew them as shown in **Figure 10**.

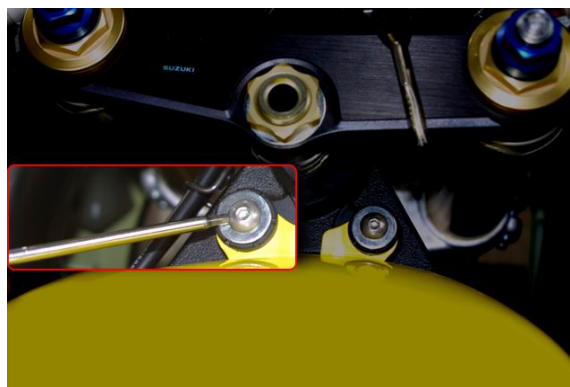

Figure 10: how to remove the fuel tank

Once the screws are removed, it is possible to lift the fuel tank using the bike standard equipment as shown in **Figure 11**.



Figure 11: lifting the fuel tank

2.3 – Releasing the high beam and the front fairing screws.

The 3rd installation step is releasing the high beam and the front fairing screws, to install more easily the kit. These screws are self threading Phillips.

In **Figure 12** is highlighted one of the two remaining screws of the fairing.

Note: in the Figure the screws has already been removed.



Figure 12: front fairing and high beam screws position

Once released these screws, pull (softly) the front fairing onwards to fix the lateral screws of the new dash (see **Figures 28 e 30** for further information).

While pulling the fairing, pay attention not to disconnect the high beam that may fall down.

Note: to pull the fairing onwards, screws and pins should have been removed.

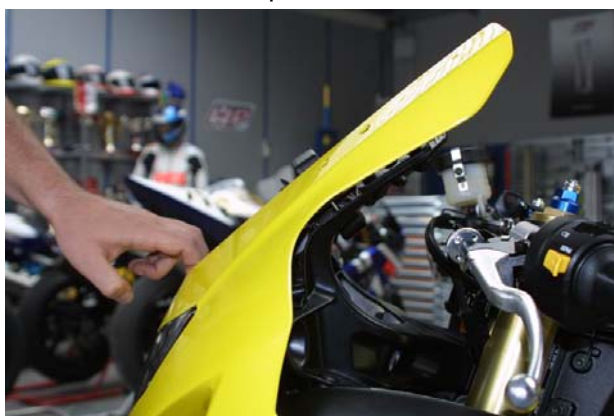

Figure 13: front fairing and high beam screws released.

2.4 – Removing the stock dash; unplugging the connectors

The fourth installation step is removing the stock dash and unplugging the stock connectors.

The stock dash is fixed to the bike in four points: with two 5 mm hex screws in the first two and through a bracket in the other two.

Remove the hex screws highlighted in **Figure 14**.



Figure 14: stock dash front screws position.

Once removed the screws, it is possible to uninstall the stock dash and rotate it towards himself and unplug it from the high beam.



Figure 15: stock dash removal

Once removed the stock dash, unplug the 16 pins AMP connector from the back of the dash.

Remove the plastic cover, press the tongue (highlighted by an arrow **Figure 16**) and unplug the connector from the dash.

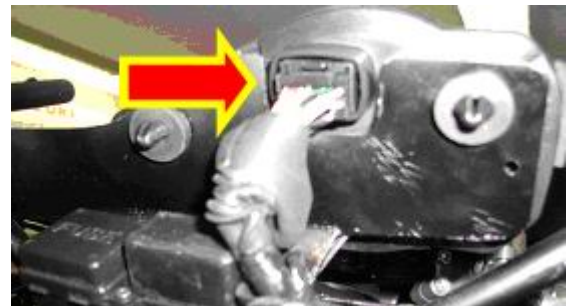

Figure 16: unplugging the stock dash connector.

Figure 17 shows gear and water temperature stock connectors default position.

For further information concerning the stock connectors refer to **Figures** from **18** to **19**.

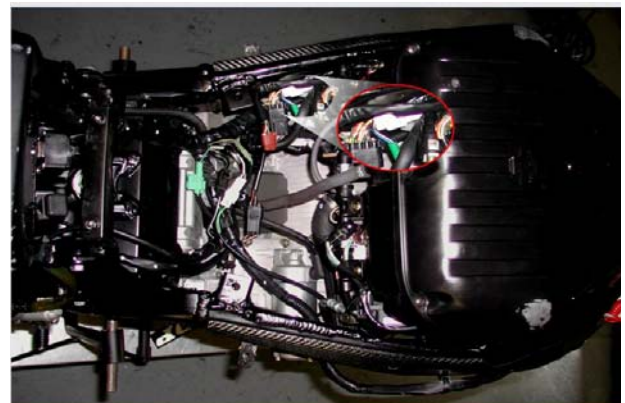

Figure 17: stock connectors position

The **gear** connector, shown in **Figure 18** is a 3 pins white connector, usually placed on the left part of the bike (see **Figure 17**).

Here below are shown the two gear connectors: male and female.

Note: cable colours correspond to real ones.

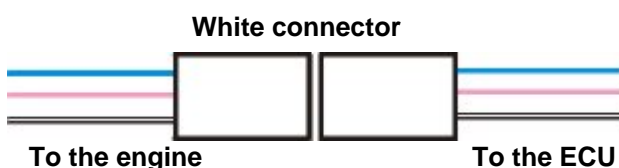
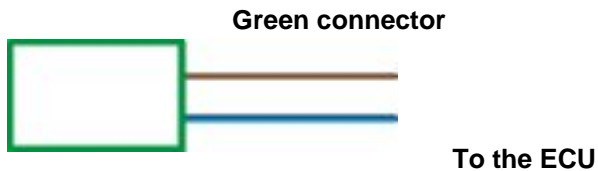

Figure 18: gear connector – particular

Water temperature stock connector, **Figure 19**, is a 2 pins green connector placed on the left part of the bike (see **Figure 17**).

Here below is the water temperature connector.

NOTE: cable colours corresponds to real ones.



3 pins male/female connector are inserted one in the other.

To unplug male connector from female one use a flat screwdriver: push down the locking tongue and unplug the connectors.

Attention: pull the connectors and not the cables (they me be seriously damaged) and unplug each cable from the connector.

2.5 – Assembling the kit.

The 5th installation step is assembling the kit for **Suzuki GSX-R**.

It has four anti-vibration mountings already fixed on the back of **MXL**;

Install **MXL** on the aluminium bracket: the bracket needs to be fixed to **MXL** in correspondence of the 4 anti-vibration mountings and with 4 screws and 4 Grover washers.

Figure 22 shows the correct assembling of **MXL**, bracket and washers (rear view).

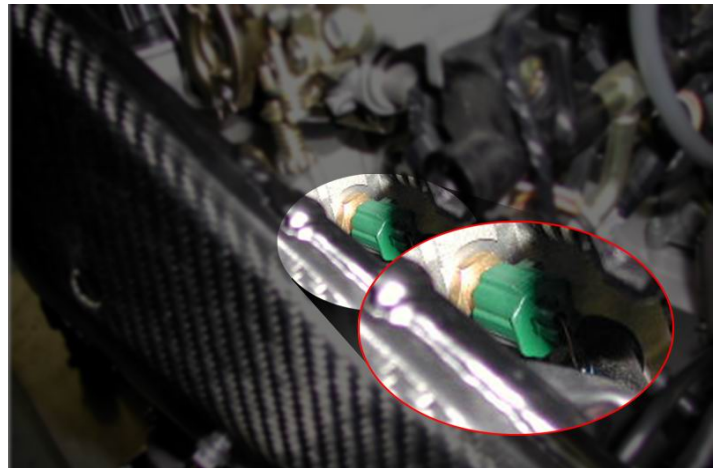

Figure 19: water temperature connector – particular



Figure 20: how to unplug a connector.

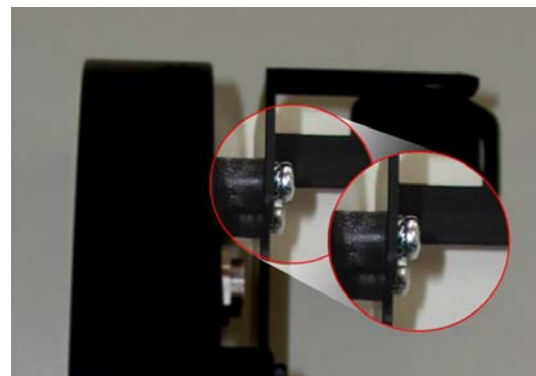

Figure 21: anti-vibration mounting – particular



Figure 22: MXL and bracket – rear view

2.6 – Cables connection

The 6th installation step is installing the wiring supplied with the kit.

The entire wiring is wrapped in a rubber girdle. Bend it 90 degrees and let it run along the bike right side.

Follows these instructions to correctly install the wiring.



Figure 23: wiring installation

Let the wiring (except cable labelled “Lap”) pass between the high beam and the front fairing.

The 2 AMP connectors, “Lap” cable and stock wiring (the one terminating with a black aluminium box), should remain over the high beam chassis.

Both AMP connector and black box are too big to pass between the chassis and the high beam. It is suggested to insert the wiring from top.

Let the cable labelled “Gear”, “Water temp” etc... pass along the bike chassis like in **Figure 25**. Use plastic wrappers to fix them to the bike stock wiring.

“Gear” and “Water temp” stock connectors are under the fuel tank and it is better to let them enter in the engine compartment as in **Figure 25**.

“Gear” and “Ch. 1 Water temp” cables have two connectors, male and female.

Connect **AIM** male connectors to female stock ones and vice versa.

Connect the 16 pins black connector to the male one in the black aluminium box (press until a click is heard). Refer to **Figure 26** for further information.

Once the 16 pins connector has been connected, use the stock dash plastic cover to make the connection water resistant.



Figure 24: kit installation



Figure 25: the wiring runs along the chassis



Figure 26: particular of AMP connector

2.7 – Installing the kit

The 7th installation step is connecting the 26 pins MS connector to **MXL**. Once installed the connector, place the black aluminium box between the bracket and the high beam.

When the channels interface box has been placed (using Velcro or plastic wrappers), install the kit on the high beam.

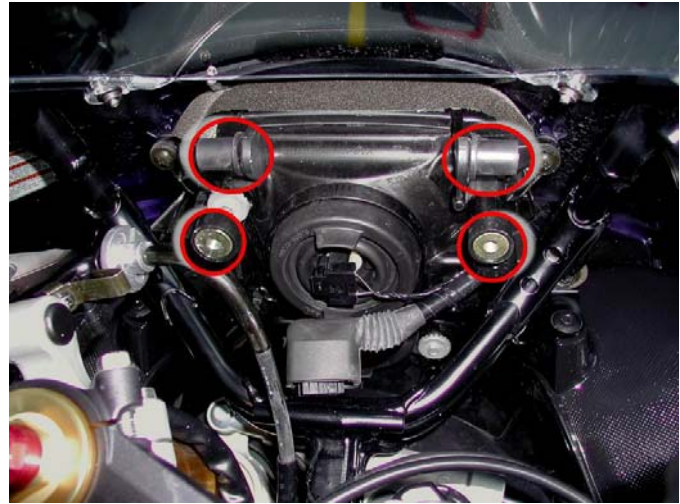

Figure 27: 4 screws position.

The new dash needs to be fixed in four points: two of them frontally visible and two lateral.

Use the M5 screws supplied with the kit to fix the new dash in the two frontal points and the Phillips thread forming screws to fix it laterally.

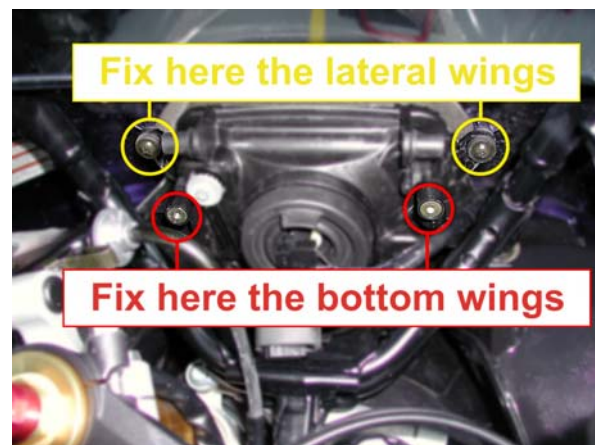

Figure 28: position of lateral and bottom wings of the bracket.

Use the thread forming screws supplied with the kit to fix the new dash laterally (**Figure 29**). The screws have to be inserted in the hole circled in **Figure 29**.

Note: the front fairing has already been pulled onwards like in Figure 13.

It is possible to use plastic wrappers to fix the new wiring to the chassis.

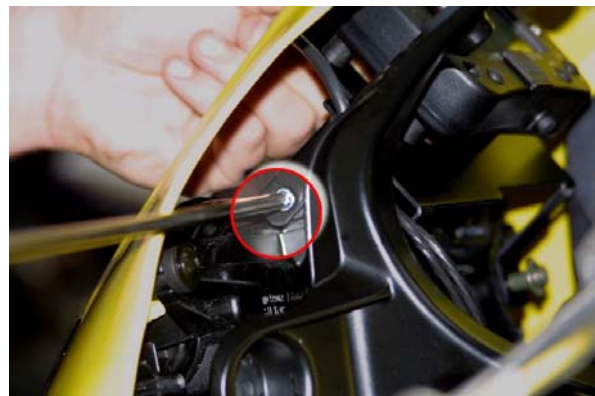
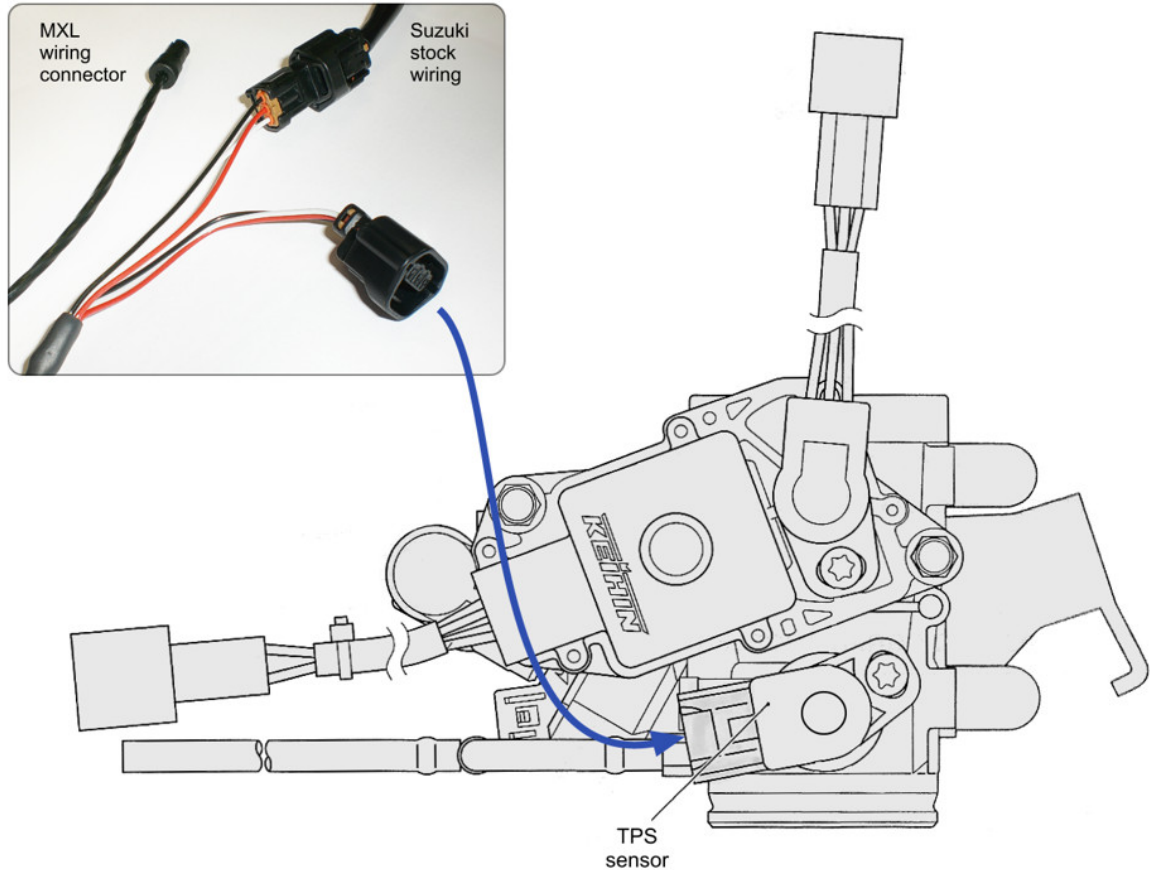

Figure 29: lateral screws fixing

Before remounting lateral fairing, front screen, bike seat and fuel tank, switch the bike on and check system integrity, its correct installation and proper working.

2.8 – Installing the TPS cable

Warning: before installing the cable it is necessary to remove the fuel tank, as recommended in the previous pages.



Unplug the Suzuki stock cable from TPS sensor and connect it to **MXL** wiring male connector labelled as TPS (as shown in the image above).

Connect female connector of **MXL** TPS cable to the TPS sensor (as shown by the blue arrow).

Connect the 4 pins male plastic Binder connector to one of the free channels depending on **MXL** model (See chapter “Channels”).

To configure the channel the TPS sensor is installed on, refer to the related chapter in the following pages.

3 – MXL connection inputs

Thanks to interfaces cable supplied with **Plug & Play Suzuki GSX-R K3** kit, data acquisition is really easy and fast.

Here below all connectors that allows the user to display data on **MXL** are shown:

- **Lap connector** (left connector), which allows lap time acquisition
- **Expansion modules connector** (right connector), for all CAN expansion modules (GPS, Lambda probe) connection
- 2 **AMP connectors** (12 and 16 pins), which allow communication between the logger and **Suzuki GSX-R K3** ECU.

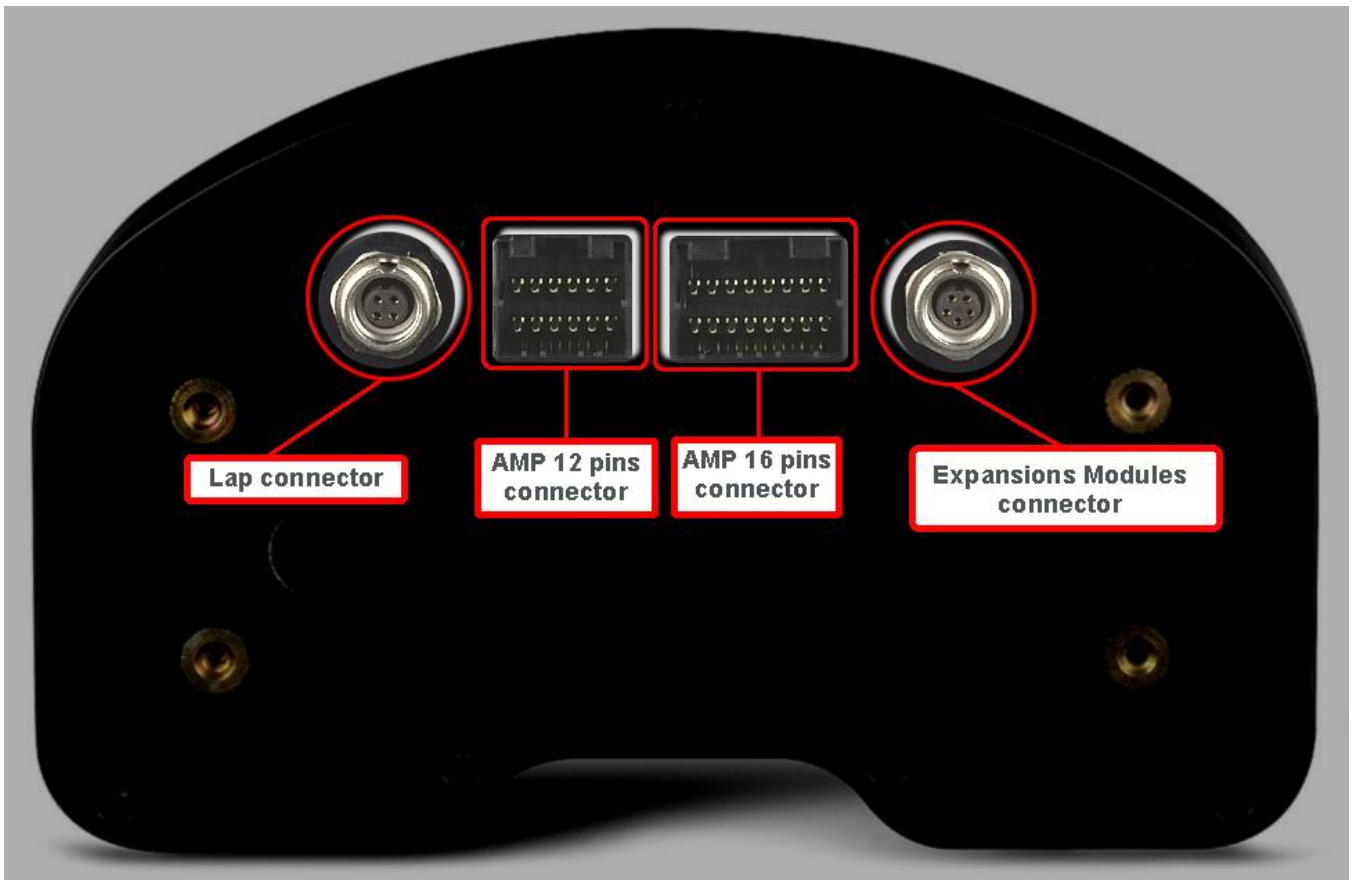

4 – MXL GSX-R K3 firmware

MXL Strada/Pista for **Suzuki GSX-R K3** is equipped with a special firmware version, that provides the user with a second virtual dashboard.

On the road, the display is set on “street mode” and shows these parameters:

RPM graph bar configurable scaling: **black**

digital RPM value / battery voltage / total and partial odometer, date and time: **fuchsia**
(VIEW/QUIT button to switch the options);

Speed: **red**

Engaged gear: **green**

Always on top analog inputs depending on **MXL** version: **blue**

Field, until 4 fields displayed two by two: **light blue**

To switch the visualization, use “>>” button.

On the track, when passing by a switched on transmitter, the display switches automatically on “track mode”.

Lap time takes the place of odometer on the display (**Figure 31**).



Figure 30: Display in modalità strada



Figure 31: Display in modalità pista

Visualisation mode (street/track) set via software is stored by the logger. Default setting is “show odometer”. If user sets via software “Show lap time” this visualisation mode is restored at each switch on, no matter if the bike is on the road or on track.

Note: for further information concerning the display management and its configuration refer to MXL Strada/ Pista/Pro and/or Race Studio Configuration user manual.

5 – Configuration

After **MXL** installation, the logger is ready to work thanks to the default configuration. In case a custom configuration is needed, here follows the correct procedure.

Run **Race Studio 2** software.

Press “AIM system manager” button on the left vertical keyboard; the panel showing all AIM systems managed through this software appears: select **MXL**.

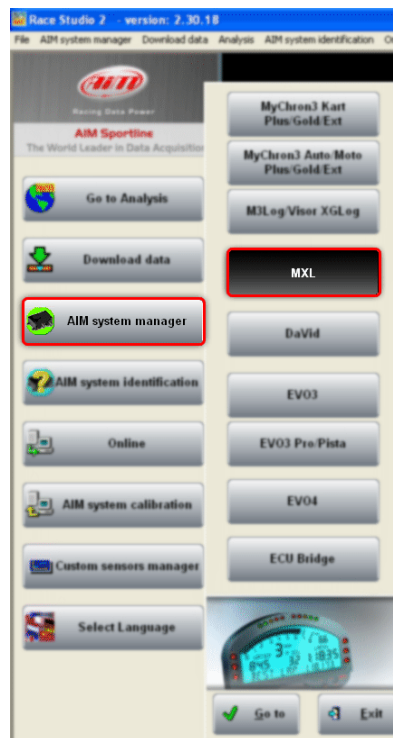

Press **New** button in system configuration window:

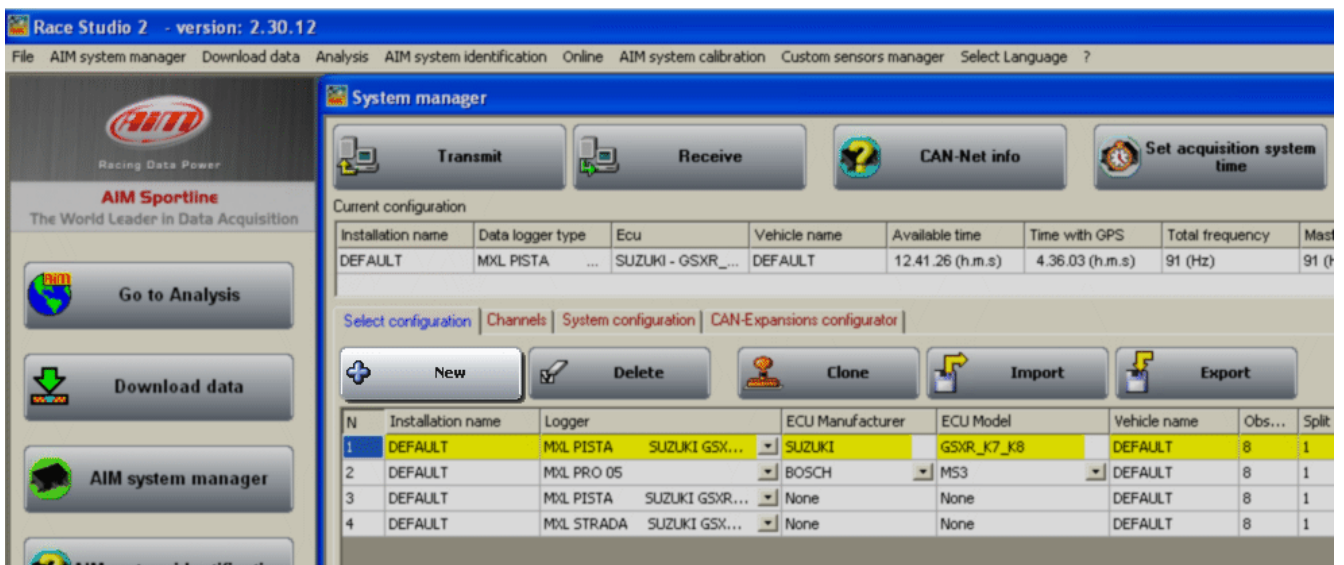

Fill in the window here below.

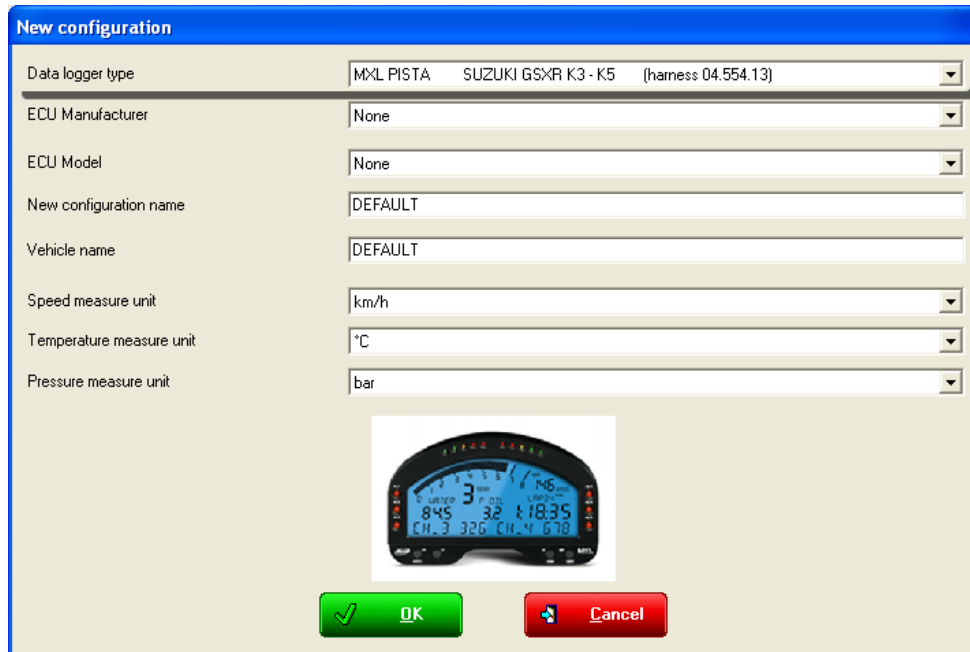

New configuration

Data logger type: MXL PISTA SUZUKI GSXR K3 - K5 (harness 04.554.13)

ECU Manufacturer: None

ECU Model: None

New configuration name: DEFAULT

Vehicle name: DEFAULT

Speed measure unit: km/h

Temperature measure unit: °C

Pressure measure unit: bar

OK Cancel

- Data logger type: select **MXL Pista** or **MXL Strada Suzuki GSX-R** depending on the kit.
- New configuration name: fill in a configuration name.
- Vehicle name: fill in a vehicle name.
- Select speeds, temperatures and pressures unit of measure.
- Click on OK button to create the configuration.

Select **Channels** layer to enter **MXL** channels configuration:

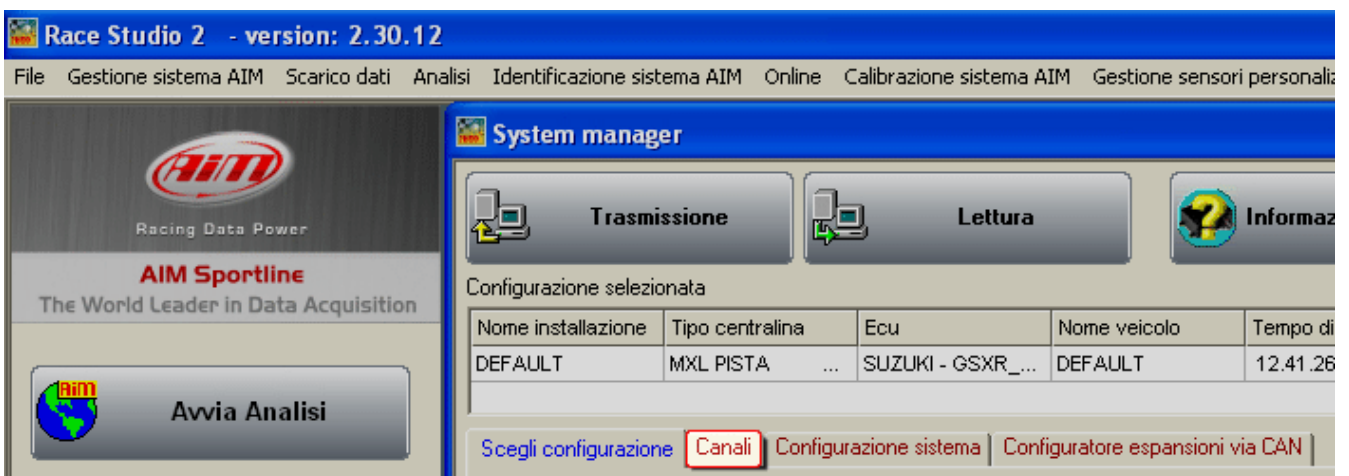

Race Studio 2 - version: 2.30.12

File Gestione sistema AIM Scarico dati Analisi Identificazione sistema AIM Online Calibrazione sistema AIM Gestione sensori personalizzati

System manager

Trasmissione Lettura Informazioni

Configurazione selezionata

Nome installazione	Tipo centralina	Ecu	Nome veicolo	Tempo di
DEFAULT	MXL PISTA	...	SUZUKI - GSXR_...	DEFAULT

Scegli configurazione **Canali** Configurazione sistema Configuratore espansioni via CAN

If an MXL Pista is being configured this window appears:

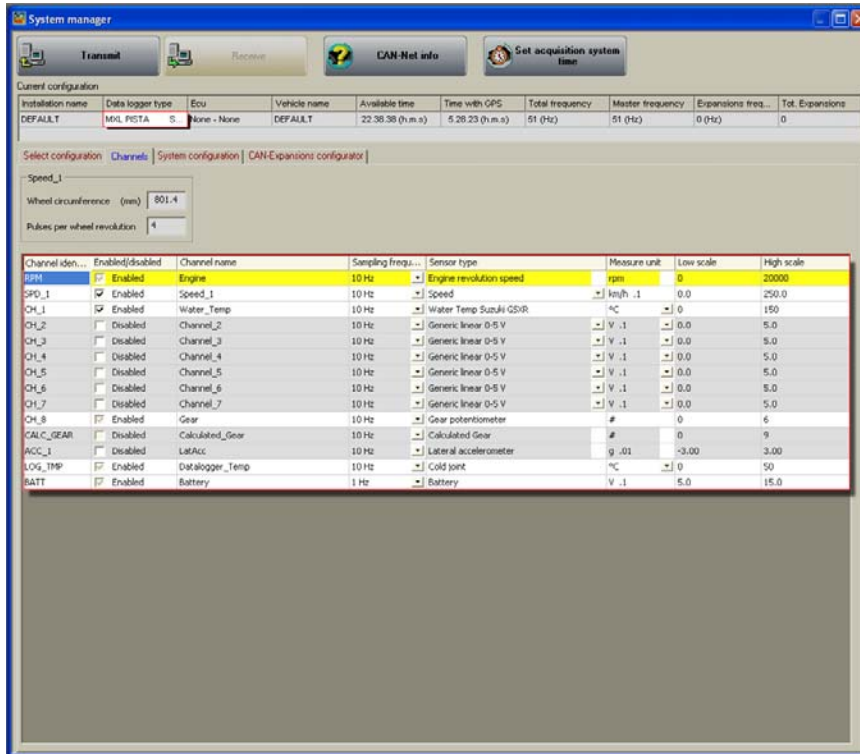

If an MXL Strada is being configured this window appears:

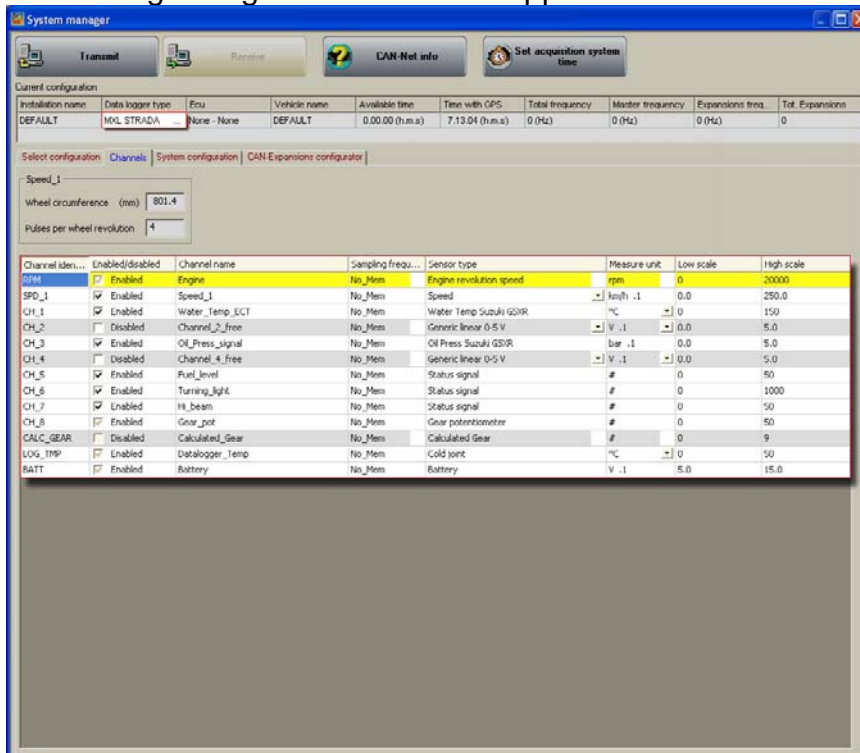

Both of them show the channels sampled by the logger.

Note: all additional analog channels are disabled by default. To configure them refer to **Race Studio Configuration** user manual.

It is now necessary to configure the display.

Select System configuration layer:

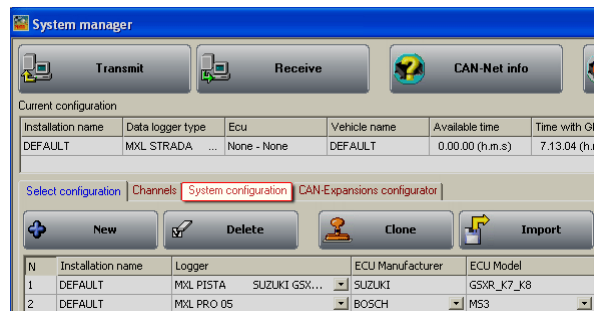

This window appears:

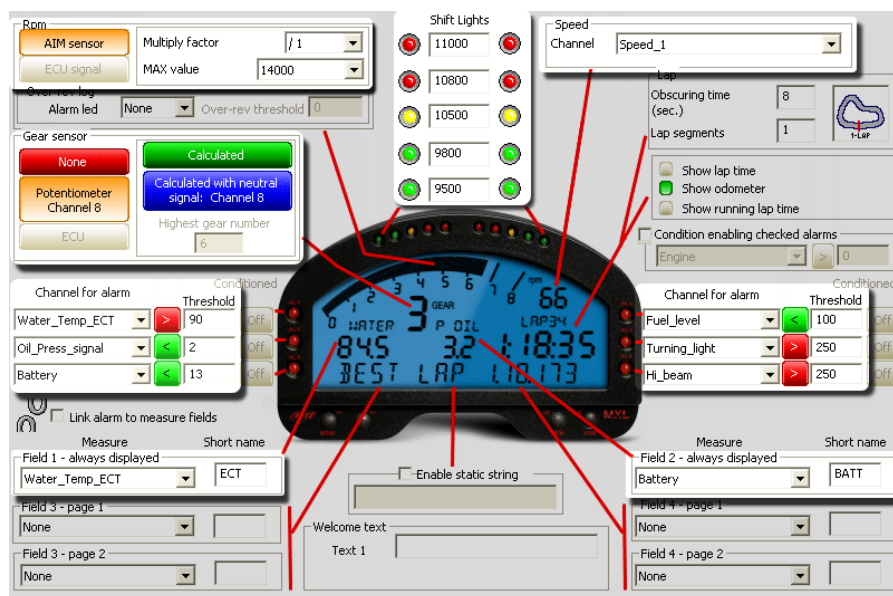

The following fields have already been set:

RPM: RPM Max value is set on 14000;

Gear sensor: the procedure explained in chapter 6 is required;

Shift light: an engine limiter at 11000 Rpm is expected. If the engine has a limiter with an higher max value, users need to modify threshold values inserted in the shift lights cases, so that the last red led switches on just before the limiter intervention.

Speed: the speed sensor of **Suzuki GSX-R K3** bike is installed on the jackshaft that connects the gearbox to the pinion. The number of magnets installed on this jackshaft is 4. The wheel circumference written in the proper cell is an “equivalent circumference” calculated using the following formula:

$$Equiv\ Circumf = \frac{Wheel\ Circumf * N_p}{N_c}$$

N_p = pinion teeth number
N_c = crown teeth number

Using the default values for crown/pinion teeth number and wheel circumference for a **Suzuki GSX-R K3 750**, the equivalent circumference is **801.4 (31.55inches)**.

If the pinion or the crown are changed and the new one has a different teeth number, equivalent circumference needs to be re-computed.

For the automatic compute of the wheel circumference, please refer to **“Equivalent circumference compute”** paragraph.

Displayed channels are:

ECT: water temperature; threshold value: Low (Min) 50° / High (Max) 90°.

ODOMETER: by default it is set on show odometer. Once on the track (with optical lap receiver and transmitter) the logger switches automatically on “Show lap time” mode. Switching on/off the **MXL** the logger shows again odometer.

Note: To modify and customize displayed channels refer to Race Studio Configuration user manual.

This way the configuration is ready and can be transmitted to **MXL**: to do so press “Transmit” button on the top keyboard.

6 – Gear calibration

Gear calibration is the last system configuration step.

This procedure is to be done only if the default one does not allow correct visualisation of the engaged gear number.

This procedure can only be done using a PC with Microsoft XP or Microsoft Vista operating system and **Race Studio 2** software (included in the kit) installed. The logger has to be connected to the PC through the proper USB cable supplied with the kit and switched on.

Once the PC connected to **MXL** and this last one switched on, run **Race Studio 2** and:

select the logger (MXL Strada / Pista GSX-R);

- press “Calibrate” button on the menu bar or “AIM System calibration” button on the left vertical keyboard



This window appears: press ‘calibrate’ button corresponding to the sensor to calibrate

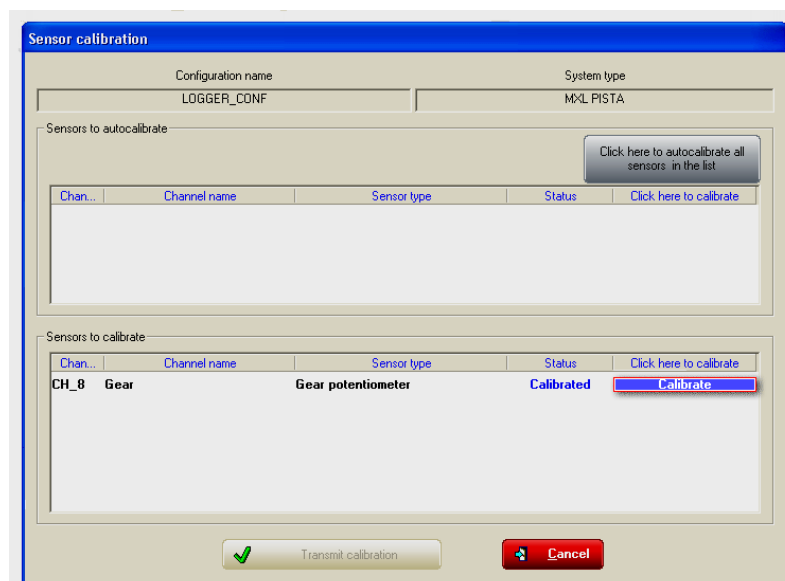

This window appears:

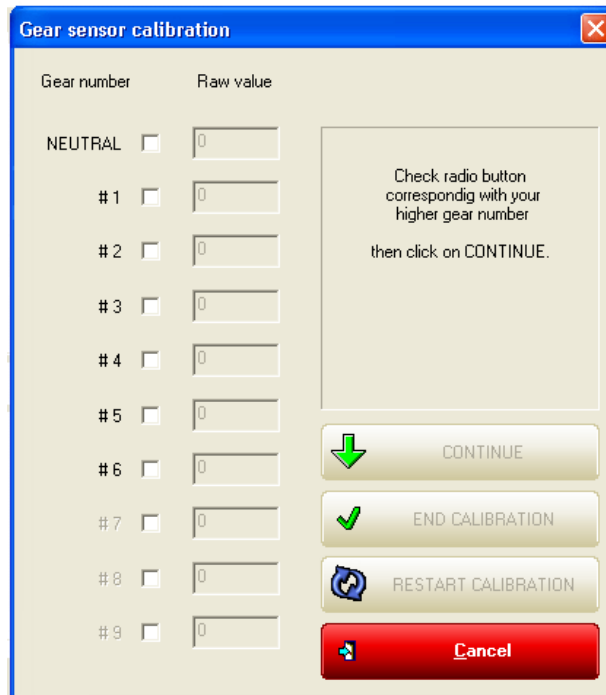

Gear number	Raw value
NEUTRAL	0
# 1	0
# 2	0
# 3	0
# 4	0
# 5	0
# 6	0
# 7	0
# 8	0
# 9	0

Check radio button correspondig with your higher gear number then click on CONTINUE.

CONTINUE

END CALIBRATION

RESTART CALIBRATION

Cancel

- Select highest gear number enabling the related checkbox and press “Continue” button;
- engage progressively all gears also with the bike switched off but the master switch on and press “Continue” button after each gear engagement as for the instructions that appear on the PC monitor. New values are stored automatically by the system.

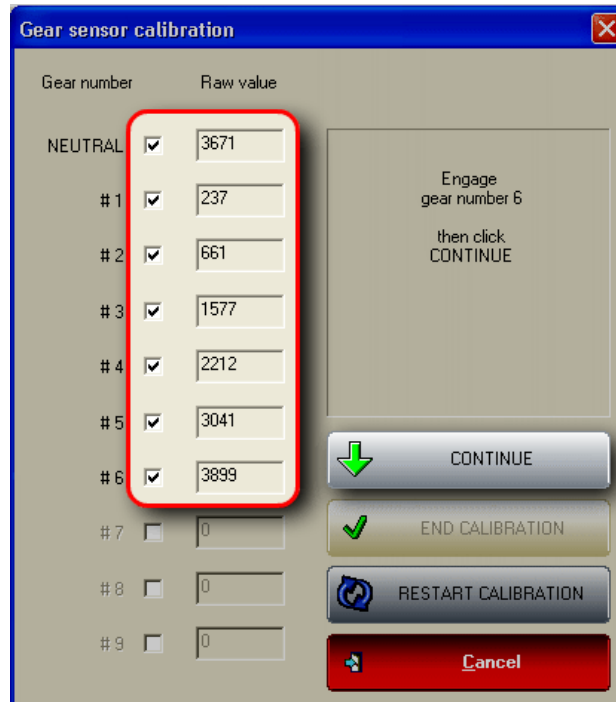

Gear number	Raw value
NEUTRAL	3671
# 1	237
# 2	661
# 3	1577
# 4	2212
# 5	3041
# 6	3899
# 7	0
# 8	0
# 9	0

Engage gear number 6 then click CONTINUE

CONTINUE

END CALIBRATION

RESTART CALIBRATION

Cancel

Once the calibration is over this window appears.

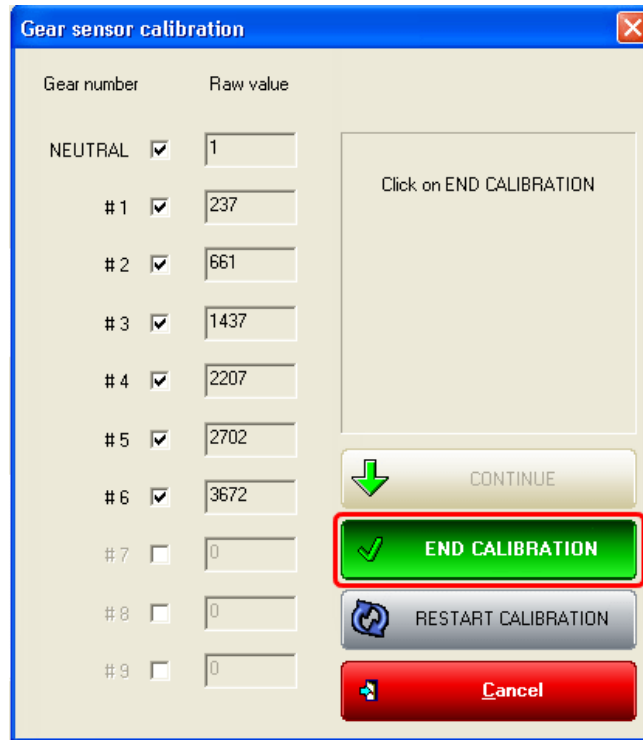

Gear number	Raw value
NEUTRAL <input checked="" type="checkbox"/>	1
# 1 <input checked="" type="checkbox"/>	237
# 2 <input checked="" type="checkbox"/>	661
# 3 <input checked="" type="checkbox"/>	1437
# 4 <input checked="" type="checkbox"/>	2207
# 5 <input checked="" type="checkbox"/>	2702
# 6 <input checked="" type="checkbox"/>	3672
# 7 <input type="checkbox"/>	0
# 8 <input type="checkbox"/>	0
# 9 <input type="checkbox"/>	0

Click on END CALIBRATION

CONTINUE

END CALIBRATION

RESTART CALIBRATION

Cancel

To finish this procedure press “End calibration” button. This window appears:

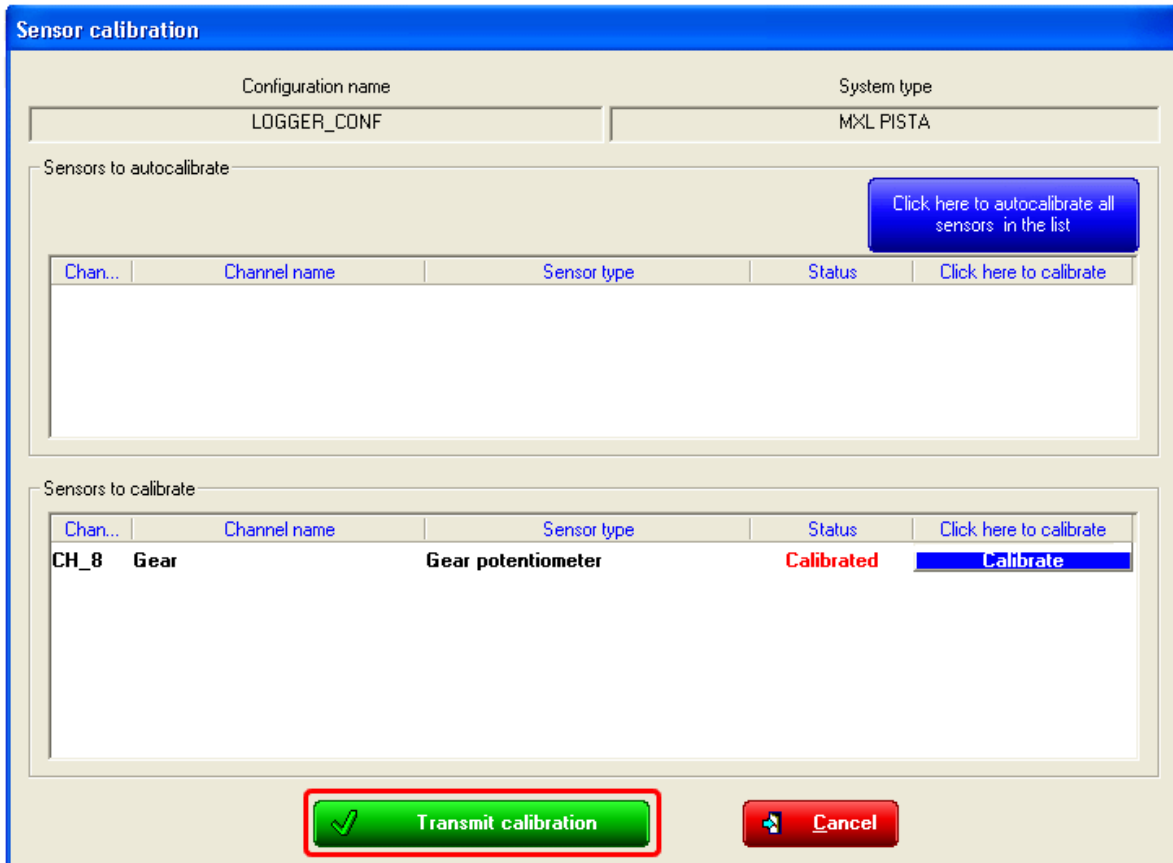

Configuration name: **LOGGER_CONF** System type: **MXL PISTA**

Sensors to autocalibrate

Click here to autocalibrate all sensors in the list

Chan...	Channel name	Sensor type	Status	Click here to calibrate

Sensors to calibrate

Chan...	Channel name	Sensor type	Status	Click here to calibrate
CH_8	Gear	Gear potentiometer	Calibrated	Calibrate

Transmit calibration

Cancel

Press “Transmit calibration” button and the new configuration is transmitted to the logger.

6.1 – Saving the configuration with custom gear calibration

To save the new configuration in **Race Studio 2** database, activate “Select configuration” layer in system configuration window and press “**Receive**” button.

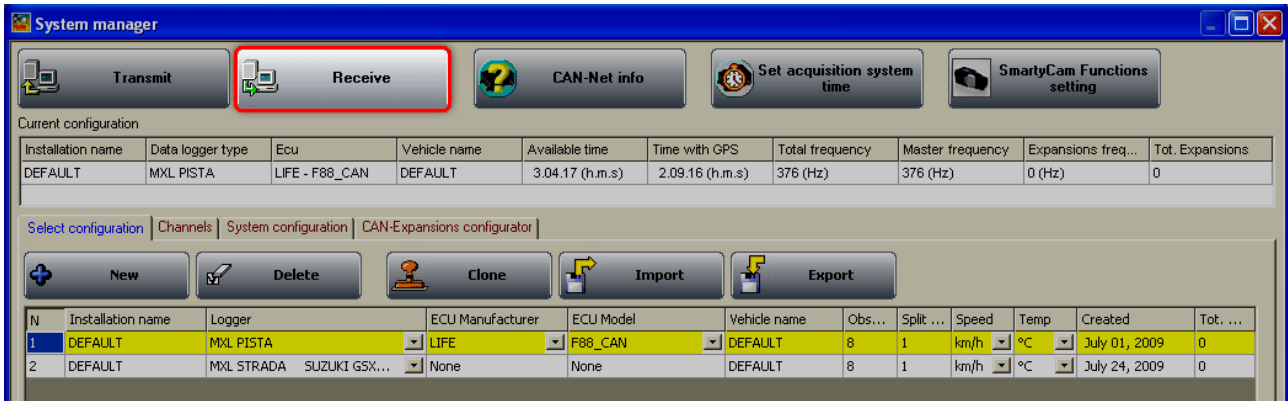

The configuration of the logger connected to the PC (the **MXL** whose configuration was previously transmitted) is read and saved as the last on bottom of configurations database (highlighted in yellow).

Note: for any further information concerning Race Studio 2 Configuration installation and use refer to the related user manual.

7 – Equivalent circumference compute

To compute the equivalent circumference, to be inserted in the correspondent cell of **Race Studio 2** software “Channels” layer, is possible to use **“Bike.exe”**.

It is placed in **“X:\Utilities”** folder -. **Race Studio 2** software CD

To do so browse the Cd:

Double click on **“Bike.exe”** icon and the following window appears.

Please:

- insert “Drive gear teeth number” (1)
- insert “Driven gear teeth number”(2)
- select circumference unit of measure (3)
- insert circumference value (4)
- press compute button



The software computes the equivalent circumference and the final value appears in the related cell (red circled).

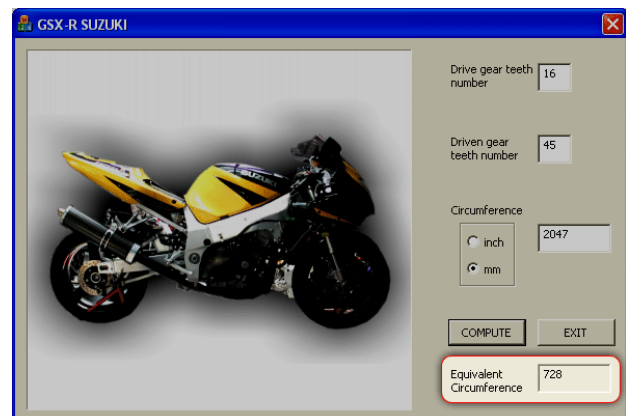

Please insert this value in the related cell of **Race Studio 2** Configuration window.

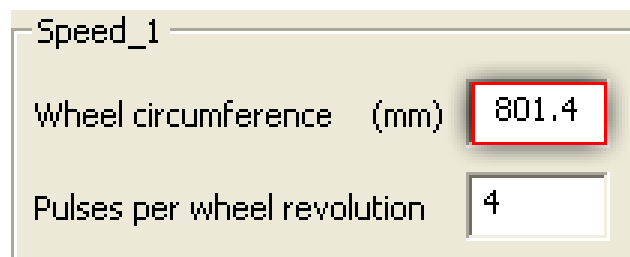

8 – TPS sensor configuration

Once the TPS sensor is installed on the bike (see the related chapter for further information), it is necessary to calibrate it so to sample correct data.

This procedure needs a PC with Microsoft XP or Microsoft Vista operating system and **Race Studio 2** software (included in the kit).

The logger has to be connected to a switched on PC through the proper cable supplied with the kit.

- run **Race Studio 2**;
- select the proper logger (**MXL Pista GSX-R K3-K5**);
- activate Channels layer;
- select a free channel depending on **MXL** model;
- enable the channel checking the related checkbox in “Enabled/Disabled” column;
- set, if desired, a channel name;
- select “Zero based Potentiometer” through the menu of “Sensor Type” column;
- set the sensor unit of measure in the cell of “Measure Unit” column;
- set high scale value (suggested 110%);
- click on “Transmit” button to transmit the configuration to the logger.

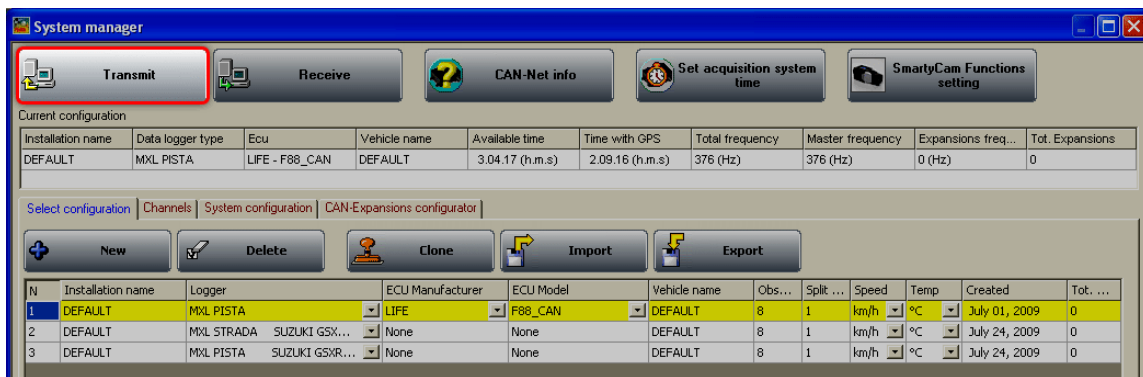

Click “Calibrate” on the left vertical keyboard or on the menu bar.



This window:

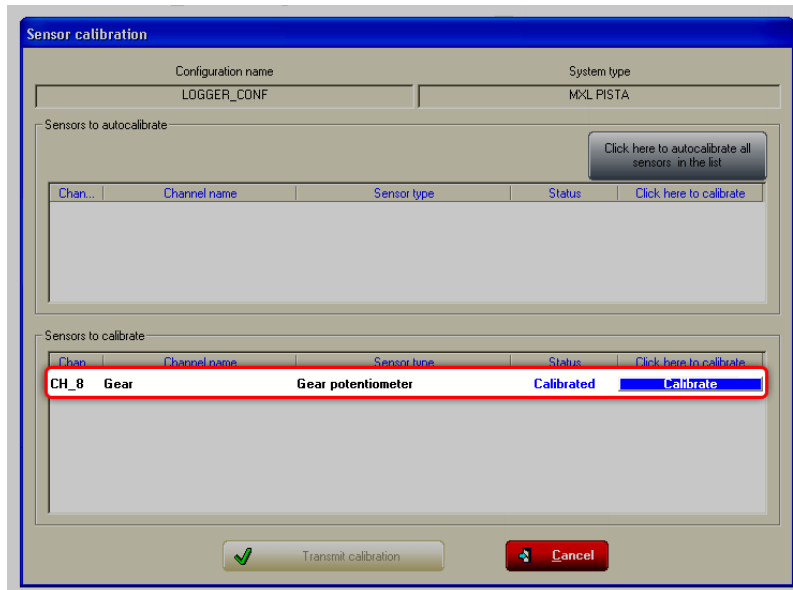

Click “calibrate” (as shown in the image below). This window appears:

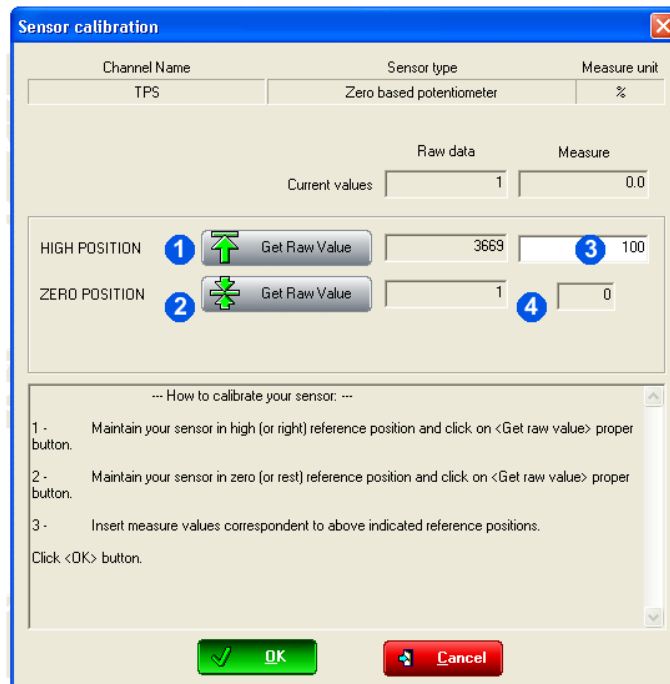

Follow the instruction that appears on the PC monitor:

- with gas completely opened press “Get raw value” button;
- with the gas in zero position, press on the corresponding “Get raw value” button;
- match acquired values with custom values to be inserted in “Measure” box;
- press OK button.

The calibration is transmitted to the logger.

9 – Channels

Channels set in **MXL Strada/ Pista** for Suzuki GSX-R default configurations are:

MXL Pista Suzuki

Channel Identifier	Channel name	Function
RPM	Engine	RPM Value
SPD_1	Speed1	Speed value
Ch_2	Channel_2	Free channel
Ch_3	Channel_3	Free channel
Ch_4	Channel_4 (12V)	Free channel
Ch_5	Channel_5 (12V)	Free channel
Ch_6	Channel_6 (12V)	Free channel
Ch_7	Channel_7 (12V)	Free channel
Ch_8	Gear	Engaged gear number
CALC_GEAR	Calculated Gear	Calculated gear
ACC_1	LatAcc	Lateral Acceleration
LOG_TMP	Datalogger_Temp	Data logger temperature
BATT	Battery	Battery voltage

MXL Strada Suzuki

Sigla Identificativa	Nome canale	Funzione
RPM	Engine	RPM Value
SPD_1	Speed_1	Speed value
Ch_1	Water_Temp_ECT	Water temperature
Ch_2	Channel 2	Free channel
Ch_3	Oil_Press_signal	Oil pressure
Ch_4	Channel 4	Free channel
Ch_5	Fuel_level	Fuel level
Ch_6	Turning_light	Turning lights ON/OFF
Ch_7	Hi_beam	High beam ON/OFF
Ch_8	Gear_pot	Gear potentiometer
CALC_GEAR	Calculated_gear	Calculated gear
LOG_TMP	Datalogger_Temp	Data logger temperature
BATT	Battery	Battery Voltage

There are other channels that, depending on the wiring the user bought, can be used to connect additional sensors like suspension potentiometers, brake pressure sensors, etc...

Note: for further information concerning additional sensors installation and configuration refer to **MXL** and **Race Studio Configuration** user manual.

10 – Data download and analysis

When a test session is over it is possible to download data stored in the logger memory and save them in a database.

Note: data download and analysis are only available on **MXL Pista**. For further information on this subject refer to **Race Studio Configuration** and **Race Studio Analysis** user manual.

11 – MXL optional expansions

Thanks to **AIM** wide range of products expressly dedicated to the different needs of each pilot, **MXL** is a modular and expandable system.

GPS Module allows the user to sample a lot of important information: brake and suspensions analysis, information concerning the vehicle chassis and analysis of the pilot behaviour in each point of the track.

This allows the user to see the track, position and related speed and even to evaluate his mistakes, exporting all information in Google Earth®. Sport performances will be reviewed through real images.



LCU – ONE CAN controls and allows the user to optimize Stoichiometric ratio (Air / Fuel) with extreme precision.

To obtain maximum engine performance, **LCU-ONE** uses a Bosch LSU 4.9 wide band probe and can detect punctual Lambda values in a range 0,65 - 1,6.

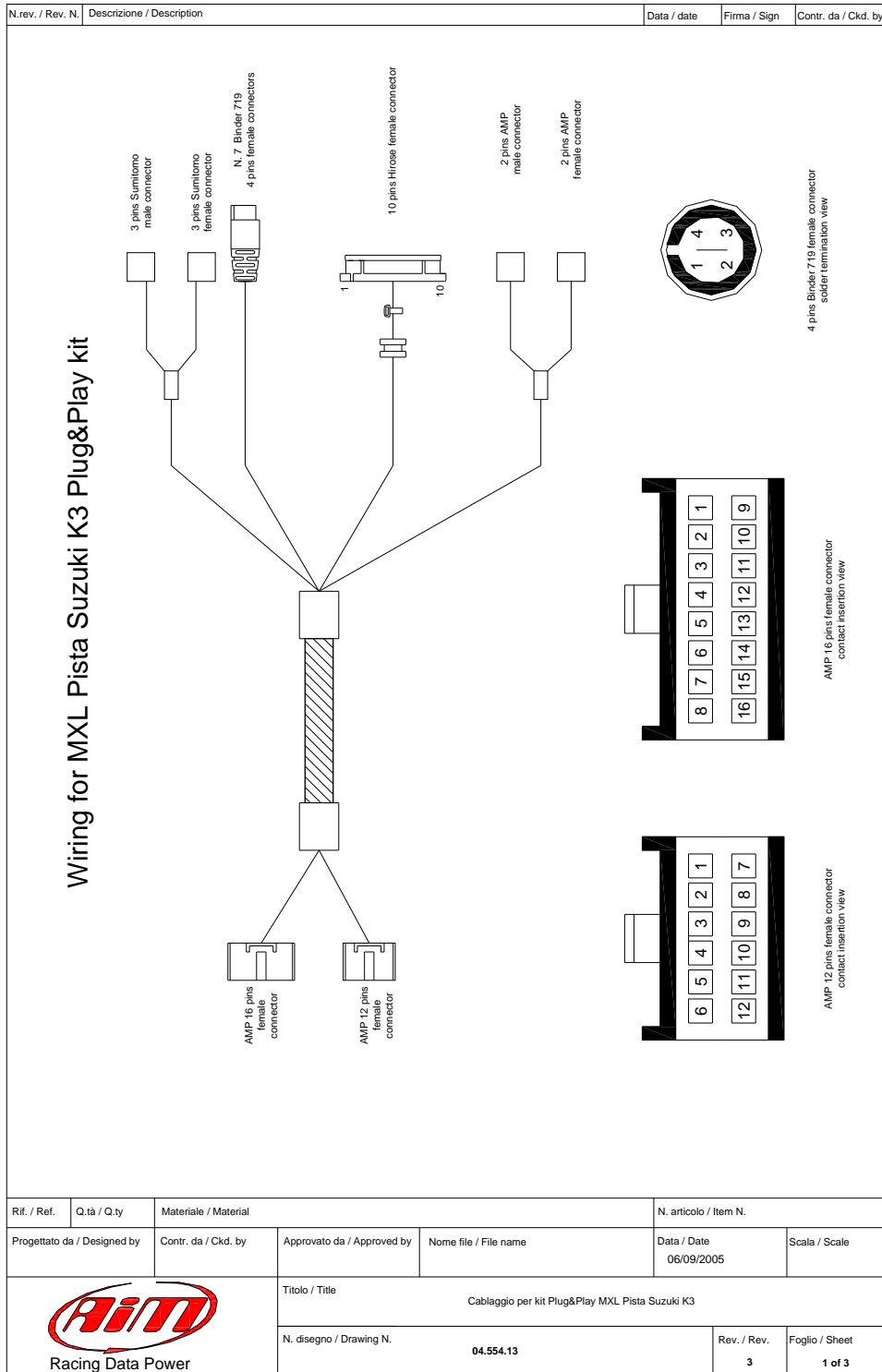

11.1 – Appendix “A” MXL for Suzuki GSX-R K3 kit wirings

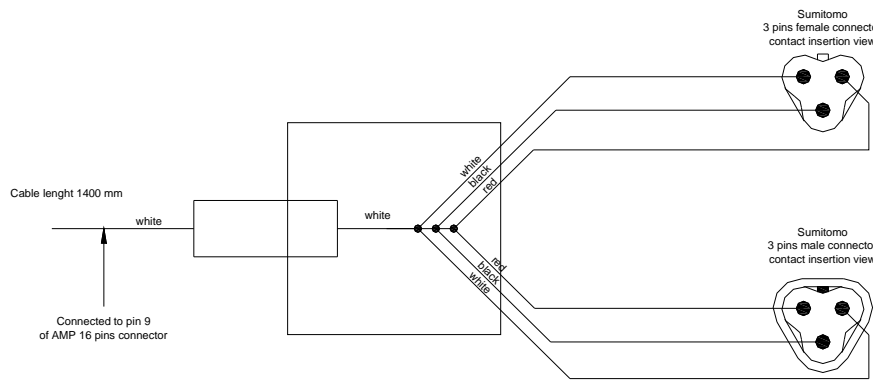
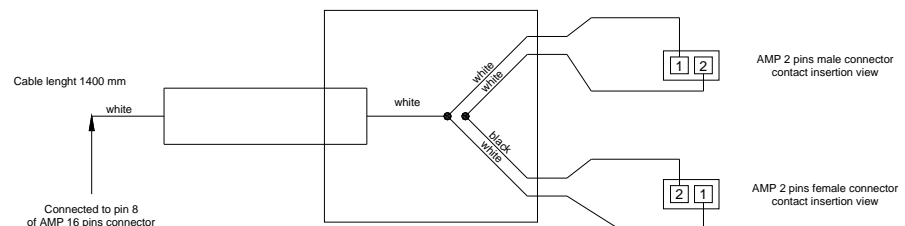

N.rev. / Rev. N.	Descrizione / Description	Data / date	Firma / Sign	Contr. da / Ckd. by
<h2 style="margin: 0;">Gear channel</h2> <p style="margin: 0;">Cable label: "Ch. 8 - Gear"</p>				
				
<h2 style="margin: 0;">Water temperature channe</h2> <p style="margin: 0;">Cable label: "Ch. 1 - Water T."</p>				
				
Rif. / Ref.	Q.tà / Q.ty	Materiale / Material		N. articolo / Item N.
Progettato da / Designed by	Contr. da / Ckd. by	Approvato da / Approved by	Nome file / File name	Data / Date 06/09/2005
		Titolo / Title Cablaggio per kit Plug&Play MXL Pista Suzuki K3		
		N. disegno / Drawing N. 04.554.13	Rev. / Rev. 3	Foglio / Sheet 2 of 3

N.rev. / Rev. N.	Descrizione / Description	Data / date	Firma / Sign	Contr. da / Ckd. by
------------------	---------------------------	-------------	--------------	---------------------

10 pins Hirose female connector table



Channel	AMP 12 pins pin	cable colour	Hirose pin	connection	cable length
On-board rev counter	2	Red	1	n.c.	420 mm
	1	Black	2	12V / +Vbext	
	11	Green	3	n.c.	
	12	Grey	4	GND	
			5	n.c.	
			6	+Vb	
			7	Speed	
			8	n.c.	
			9	n.c.	
		8	bleu	10	

Binder 719 connectors table

Channel	Binder pin	Cable colour	AMP 12 pins pin	AMP 16 pins pin	connection	cable length
Ch.2	1	white		5	Analog input 2	330 mm
	2	black		7	Analog GND	
	3	red				
	4	bleu		6	V reference	
Ch.3	1	white		4	Analog input 3	330 mm
	2	black		3	Analog GND	
	3	red				
	4	bleu		6	V reference	
Ch.4	1	white		1	Analog input 4	380 mm
	2	black		3	Analog GND	
	3	red	9		+VB	
	4	bleu		2	V reference	
Ch.5	1	white		16	Analog input 5	380 mm
	2	black		15	Analog GND	
	3	red	9		+VB	
	4	bleu		2	V reference	
Ch.6	1	white		13	Analog input 6	430 mm
	2	black		15	Analog GND	
	3	red	11		+VB	
	4	bleu		2	V reference	
Ch.7	1	white		12	Analog input 7	430 mm
	2	black		11	Analog GND	
	3	red	11		+VB	
	4	bleu		14	V reference	
USB	1	white		10	USB D+	1080 mm
	2	black	10		GND	
	3	red	7		USB D-	
	4	n.c.				

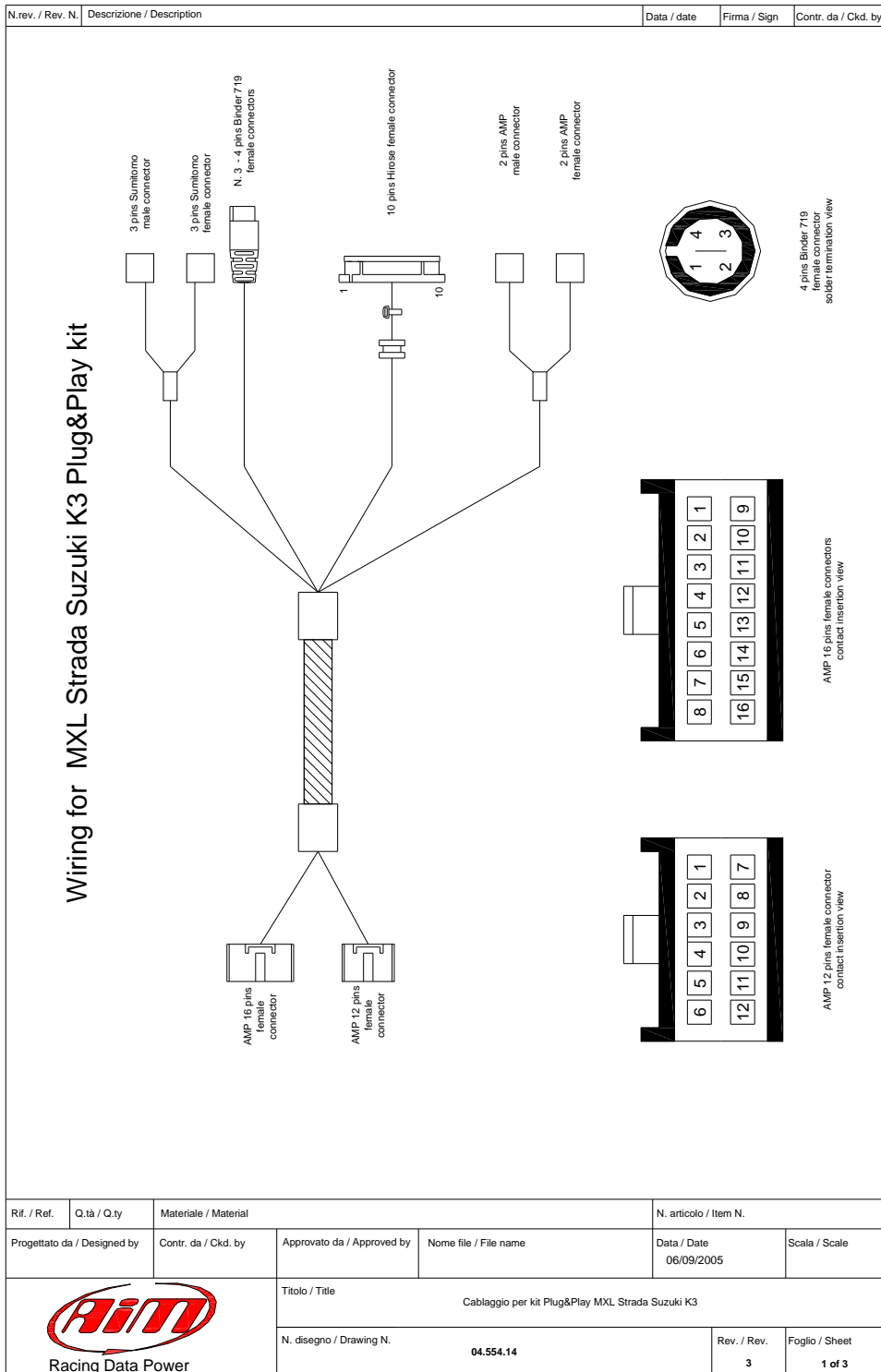
Rif. / Ref.	Q.tà / Q.ty	Materiale / Material			N. articolo / Item N.		
Progettato da / Designed by	Contr. da / Ckd. by	Approvato da / Approved by	Nome file / File name		Data / Date	Scala / Scale	
					06/09/2005		
		Titolo / Title					
		Cablaggio per kit Plug&Play MXL Pista Suzuki K3					
		N. disegno / Drawing N.			Rev. / Rev.	Foglio / Sheet	
		04.554.13			3	3 of 3	

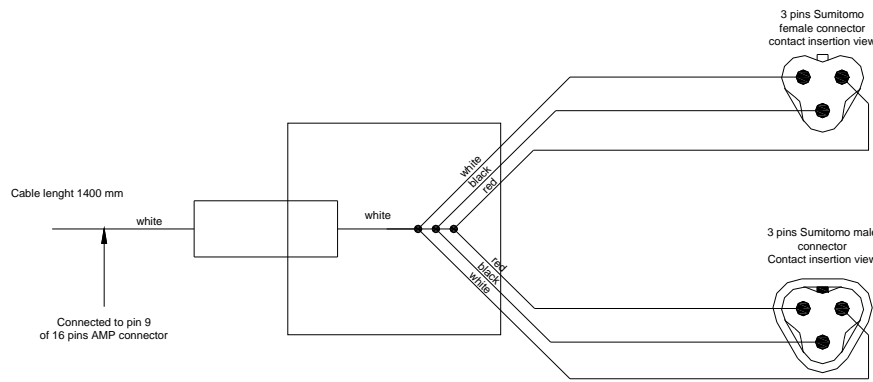
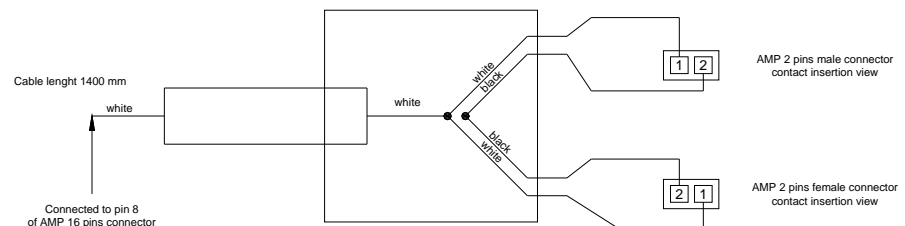

N.rev. / Rev. N.	Descrizione / Description	Data / date	Firma / Sign	Contr. da / Ckd. by
<h2 style="margin: 0;">Gear channel</h2> <p style="margin: 0;">Cable label: "Ch. 8 - Gear"</p>				
				
<h2 style="margin: 0;">Water temperature channel</h2> <p style="margin: 0;">Cable label: "Ch. 1 - Water T."</p>				
				
Rif. / Ref.	Q.tà / Q.ty	Materiale / Material	N. articolo / Item N.	
Progettato da / Designed by	Contr. da / Ckd. by	Approvato da / Approved by	Nome file / File name	Data / Date 06/09/2005
		Titolo / Title Cablaggio per kit Plug&Play MXL Strada Suzuki K3		
		N. disegno / Drawing N. 04.554.14	Rev. / Rev. 3	Foglio / Sheet 2 of 3

N.rev. / Rev. N.	Descrizione / Description	Data / date	Firma / Sign	Contr. da / Ckd. by
------------------	---------------------------	-------------	--------------	---------------------

10 pins Hirose female connector table

Channels	AMP 12 pins pin	AMP 16 pins pin	cable colour	Hirose pin	conection	cable lenght
On-board rev counter	2		Red	1	n.c.	420 mm
	1	4	Brown	2	12V / +Vbext	
			Black	3	Oil P / Ch.3	
	11	12	Yellow	4	GND	
	12		Green	5	High beam / Ch.7	
			Grey	6	+VB	
			Purple	7	Speed	
		13	White	8	Dir Light / Ch. 6	
		16	Bleu	9	Fuel / Ch. 5	
	8			10	RPM	

Binder 719 connectors table

Channel	Binder pin	Cable colour	AMP 12 pins pin	AMP 16 pins pin	connection	cable lenght
Ch.2	1	white		5	Analog input 2	330 mm
	2	black		7	Analog GND	
	3	red				
	4	bleu		6	V reference	
Ch.4	1	white		1	Analog input 4	380 mm
	2	black		3	Analog GND	
	3	red	9			
	4	bleu		2	V reference	
USB	1	white		10	USB D+	1080 mm
	2	black	10		GND	
	3	red	7		USB D-	
	4	n.c.				

Rif. / Ref.	Q.tà / Q.ty	Materiale / Material		N. articolo / Item N.		
Progettato da / Designed by	Contr. da / Ckd. by	Approvato da / Approved by	Nome file / File name	Data / Date	Scala / Scale	
				06/09/2005		
 Racing Data Power		Titolo / Title				
		Cablaggio per kit Plug&Play MXL Strada Suzuki K3				
N. disegno / Drawing N.			04.554.14	Rev. / Rev.	Foglio / Sheet	
				3	3 of 3	

11.2 – Appendix “B” TPS Cable

