

N.rev. / Rev. N.	Descrizione / Description	Data / date	Firma / Sign	Contr. da / Ckd. by
------------------	---------------------------	-------------	--------------	---------------------

MXL Strada pinout

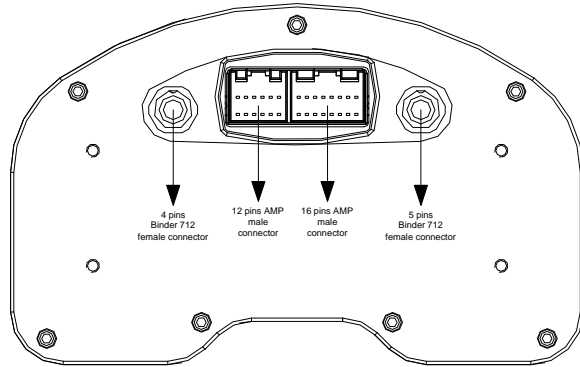

4 pins Binder 712 female connector pinout - Beacon

Pin	Function
1	Magnetic Lap
2	GND
3	+VB
4	Optical Lap

12 pins AMP male connector pinout

Pin	Function
1	GND
2	External power 9-15 V
3	CAN 1- ECU interface
4	CAN 1+ ECU interface
5	RS232TX
6	RS232RX
7	USB D-
8	RPM 150-400V coil and RPM square wave (>8V)
9	+VB
10	GND
11	+VB
12	Speed

16 pins AMP male connector pinout

Pin	Function
1	Analog channel 4
2	V Reference
3	Analog GND
4	Analog channel 3
5	Analog channel 2
6	V Reference
7	Analog GND
8	Analog channel 1
9	Analog channel 8
10	USB D+
11	Analog GND
12	Analog channel 7
13	Analog channel 6
14	V Reference
15	Analog GND
16	Analog channel 5

5 pins Binder 712 female connector pinout - Exp

Pin	Function
1	Can 0+
2	GND
3	+VB
4	Can 0-
5	9-15 V Battery

Rif. / Ref.	Q.tà / Q.ty	Materiale / Material	N. articolo / Item N.			
Progettato da / Designed by L.I.		Contr. da / Ckd. by	Approvato da / Approved by	Nome file / File name	Data / Date	Scala / Scale
 Racing Data Power		Titolo / Title Pinout MXL Strada				
		N. disegno / Drawing N.			Rev. / Rev.	Foglio / Sheet 1 of 1

N.rev. / Rev. N.	Descrizione / Description	Data / date	Firma / Sign	Contr. da / Ckd. by
------------------	---------------------------	-------------	--------------	---------------------

MXL Strada standard cable

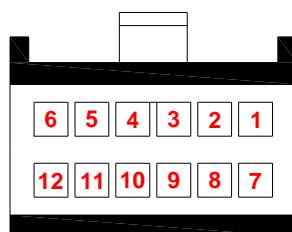
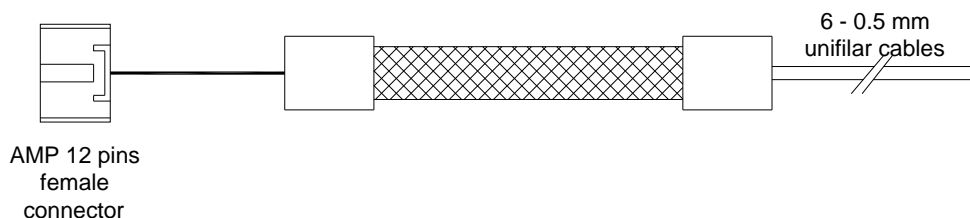

AMP 12 pins female connector pinout
Contact insertion view

Non cabled channels table

Channels	Cable Colour	AMP 12 pin	Connection	Lenght
Power	red black	2	9 -15 VDC GND	500 mm
		1		
CAN	white blue	4	CAN + CAN -	500 mm
		3		
RS 232	white blue	6	RS 232 RX RS 232 TX	500 mm
		5		

Rif. / Ref.	Q.tà / Q.ty	Materiale / Material	N. articolo / Item N.		
Progettato da / Designed by L.I.	Contr. da / Ckd. by	Approvato da / Approved by	Nome file / File name	Data / Date	Scala / Scale
 Racing Data Power		Titolo / Title Cavo Standard MXL Strada			
		N. disegno / Drawing N. 04.554.09	Rev. / Rev.	Foglio / Sheet 1 of 1	

N.rev. / Rev. N.	Descrizione / Description	Data / date	Firma / Sign	Contr. da / Ckd. by
------------------	---------------------------	-------------	--------------	---------------------

Cable standard for MXL Pista and optional for MXL Strada

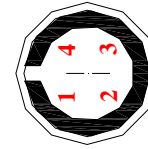
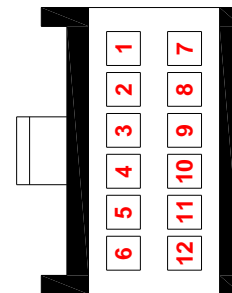
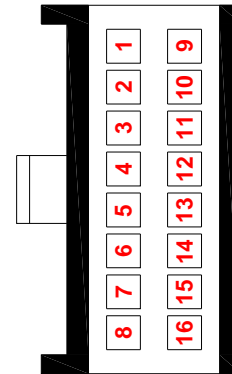
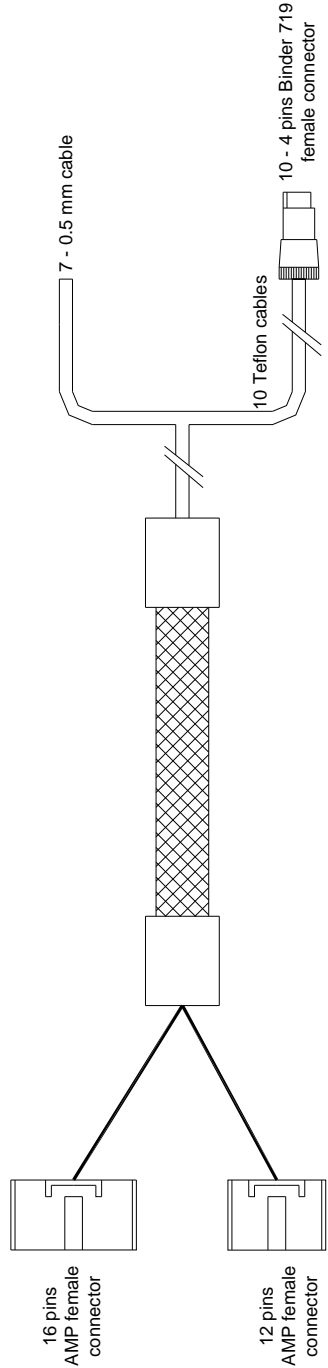



Rif. / Ref.	Q.tà / Q.ty	Materiale / Material	N. articolo / Item N.	
Progettato da / Designed by L.I.	Contr. da / Ckd. by	Approvato da / Approved by	Nome file / File name	Data / Date
 Racing Data Power		Titolo / Title Cavo standard per MXL Pista ed optional per MXL Strada		
		N. disegno / Drawing N. 04.554.02	Rev. / Rev.	Foglio / Sheet 1 of 3

N.rev. / Rev. N.	Descrizione / Description	Data / date	Firma / Sign	Contr. da / Ckd. by
------------------	---------------------------	-------------	--------------	---------------------

Binder 719 connector Table

Chanel	Binder pin	Cable Colour	AMP 12 pin	AMP 16 pin	Connection	Lenght
Ch. 1	1	White		8	Analog input 1	350 mm
	2	Black		7	Analog GND	
	3	Red				
	4	Bleu		6	V reference	
Ch. 2	1	White		5	Analog input 2	350 mm
	2	Black		7	Analog GND	
	3	Red				
	4	Bleu		6	V reference	
Ch. 3	1	White		4	Analog input 3	350 mm
	2	Black		3	Analog GND	
	3	Red				
	4	Bleu		6	V reference	
Ch. 4	1	White		1	Analog input 4	400 mm
	2	Black		3	Analog GND	
	3	Red	9		+ VB	
	4	Bleu		2	V reference	
Ch. 5	1	White		16	Analog input 5	400 mm
	2	Black		15	Analog GND	
	3	Red	9		+ VB	
	4	Bleu		2	V reference	
Ch. 6	1	White		13	Analog input 6	400 mm
	2	Black		15	Analog GND	
	3	Red	9		+ VB	
	4	Bleu		2	V reference	
Ch. 7	1	White		12	Analog input 7	450 mm
	2	Black		11	Analog GND	
	3	Red	11		+ VB	
	4	Bleu		14	V reference	
Ch. 8	1	White		9	Analog input 8	450 mm
	2	Black		11	Analog GND	
	3	Red	11		+ VB	
	4	Bleu		14	V reference	
Speed	1	White	12		Speed GND + VB	450 mm
	2	Black	10			
	3	Red	11			
	4	Bleu				
USB	1	White		10	USB D+ GND USB D-	1000 mm
	2	Black	10			
	3	Red	7			
	4	n.c.				

Rif. / Ref.	Q.tà / Q.ty	Materiale / Material		N. articolo / Item N.		
Progettato da / Designed by L.I.		Contr. da / Ckd. by	Approvato da / Approved by	Nome file / File name	Data / Date	Scala / Scale
 Racing Data Power		Titolo / Title Cavo standard per MXL Pista ed optional per MXL Strada				
		N. disegno / Drawing N. 04.554.02		Rev. / Rev.	Foglio / Sheet 2 of 3	

N.rev. / Rev. N.	Descrizione / Description			Data / date	Firma / Sign	Contr. da / Ckd. by																															
<h2>Not cabled channels table</h2> <table border="1"> <thead> <tr> <th>Channel</th> <th>Cable colour</th> <th>AMP 12 pin</th> <th>Connection</th> <th>Lenght</th> </tr> </thead> <tbody> <tr> <td rowspan="2">Power</td> <td>Red</td> <td>2</td> <td rowspan="2">9-15 VDC GND</td> <td rowspan="2">500 mm</td> </tr> <tr> <td>Black</td> <td>1</td> </tr> <tr> <td>RPM</td> <td>White</td> <td>8</td> <td>RPM Coil - Square Wave</td> <td>500 mm</td> </tr> <tr> <td rowspan="2">CAN</td> <td>White</td> <td>4</td> <td rowspan="2">CAN+ CAN-</td> <td rowspan="2">500 mm</td> </tr> <tr> <td>Blu</td> <td>3</td> </tr> <tr> <td rowspan="2">RS232</td> <td>White</td> <td>6</td> <td rowspan="2">RS232RX RS232TX</td> <td rowspan="2">500 mm</td> </tr> <tr> <td>Blu</td> <td>5</td> </tr> </tbody> </table>							Channel	Cable colour	AMP 12 pin	Connection	Lenght	Power	Red	2	9-15 VDC GND	500 mm	Black	1	RPM	White	8	RPM Coil - Square Wave	500 mm	CAN	White	4	CAN+ CAN-	500 mm	Blu	3	RS232	White	6	RS232RX RS232TX	500 mm	Blu	5
Channel	Cable colour	AMP 12 pin	Connection	Lenght																																	
Power	Red	2	9-15 VDC GND	500 mm																																	
	Black	1																																			
RPM	White	8	RPM Coil - Square Wave	500 mm																																	
CAN	White	4	CAN+ CAN-	500 mm																																	
	Blu	3																																			
RS232	White	6	RS232RX RS232TX	500 mm																																	
	Blu	5																																			
Rif. / Ref.	Q.tà / Q.ty	Materiale / Material			N. articolo / Item N.																																
Progettato da / Designed by L.I.		Contr. da / Ckd. by	Approvato da / Approved by	Nome file / File name	Data / Date	Scala / Scale																															
 <p>Racing Data Power</p>		Titolo / Title Cavo standard per MXL Pista ed optional per MXL Strada																																			
		N. disegno / Drawing N. 04.554.02			Rev. / Rev.	Foglio / Sheet 3 of 3																															

N.rev. / Rev. N.	Descrizione / Description	Data / date	Firma / Sign	Contr. da / Ckd. by
------------------	---------------------------	-------------	--------------	---------------------

USB cable for data download - 3.5 mm stereo Jack

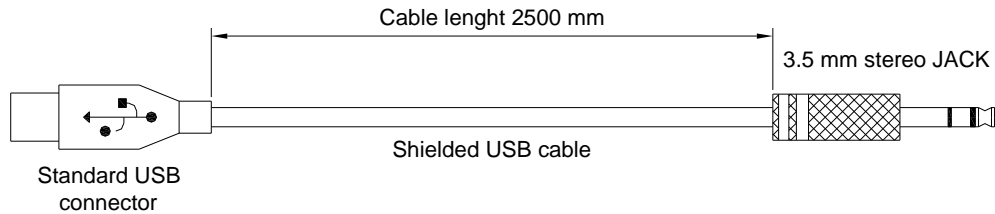

Pin connection

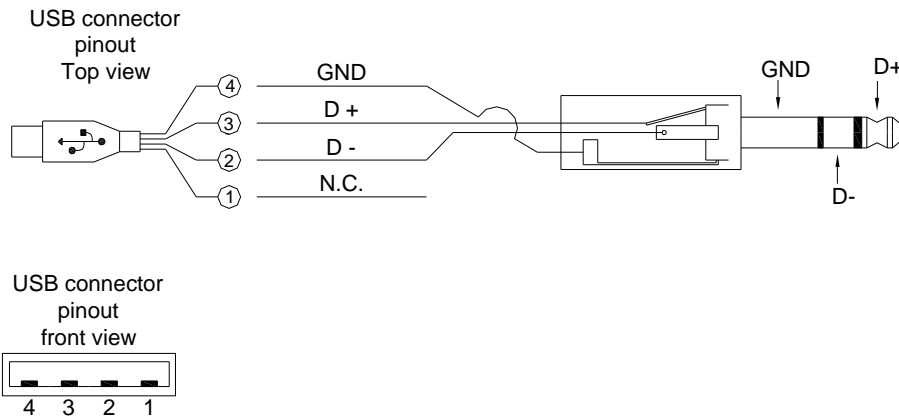

Rif. / Ref.	Q.tà / Q.ty	Materiale / Material	N. articolo / Item N.	
Progettato da / Designed by	Contr. da / Ckd. by	Approvato da / Approved by	Nome file / File name	Scala / Scale
		Titolo / Title		
		Cavo USB per scarico dati - Jack da 3.5 mm stereo		
N. disegno / Drawing N.		04.554.30	Rev. / Rev.	Foglio / Sheet
				1 of 1